

Distinctive Characteristics

Sealed construction prevents contact contamination and allows automated soldering and cleaning. Sealed design accomplished with seals between the actuator and housing and between housing and base.

Highly visible legends and choice of screwdriver or shaft actuation to provide trouble-free code setting.

Detent mechanism designed for crisp, positive action for accurate switch setting.

Bifurcated, spring loaded contacts give unmatched logic-level reliability.

Heat tolerant resin used for body meets UL flammability rating of 94V-0 and maintains switch reliability through automated soldering process.

Crimped terminals ensure secure PC mounting and prevent dislodging during soldering.

.100" (2.54mm) terminal grid spacing between pin centers, plus 3-by-3 terminal arrangement for footprint pattern equivalent to industry standard.

Epoxy sealed terminals lock out flux, solvents, and other contaminants.

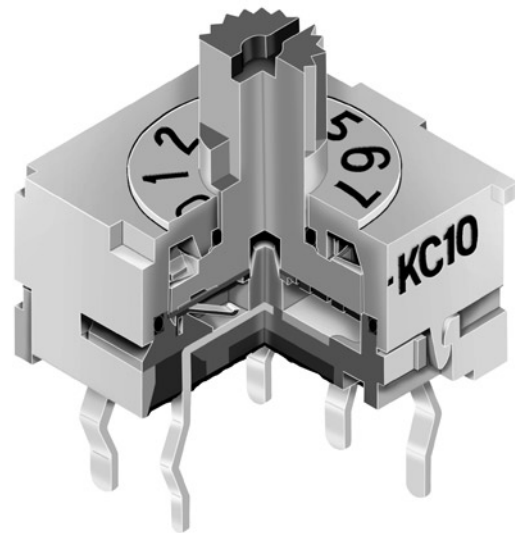

Actual Size

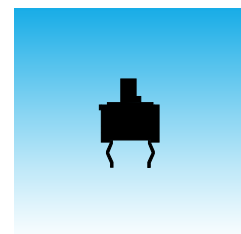

General Specifications

Electrical Capacity (Resistive Load)

Switching Rating: 100mA @ 5V DC
Nonswitching Rating: 100mA @ 50V DC

Other Ratings

Contact Resistance: 80 milliohms maximum for circuit; 30 milliohms maximum for contact point
Insulation Resistance: 1,000 megohms minimum @ 250V DC
Dielectric Strength: 250V AC minimum for 1 minute minimum
Mechanical Life: 20,000 detent operations minimum
Electrical Life: 20,000 detent operations minimum
Notes: A detent operation is one actuator position operation or stepping.
 20,000 detent operations = 1,250 cycles for hexadecimal devices or 2,000 cycles for decimal devices. A cycle is one 360° rotation.

Nominal Operating Torque: 0.006Nm
Contact Timing: Nonshorting (break-before-make)

Materials & Finishes

Actuator: Glass fiber reinforced polyamide
Housing: Glass fiber reinforced polyamide (UL94V-0)
O-ring: Nitrile butadiene rubber
Base: Glass fiber reinforced polyamide (UL94V-0)
Movable Contact: Beryllium copper with gold plating
Stationary Contacts: Brass with gold plating
Terminals: Brass with gold plating

Environmental Data

Operating Temperature Range: -25°C through +75°C (-13°F through +167°F)
Humidity: 90 ~ 95% humidity for 96 hours @ 40°C (104°F)
Vibration: 10 ~ 55Hz with peak-to-peak amplitude of 1.5mm traversing the frequency range & returning in 1 minute; 3 right angled directions for 2 hours
Shock: 50G (490m/s²) acceleration (tested in 6 right angled directions, with 5 shocks in each direction)

PCB Processing

Soldering: Wave Soldering Recommended: See Profile B in Supplement section.
 Manual Soldering: See Profile B in Supplement section.
Cleaning: Automated Cleaning. See Cleaning Specifications in Supplement section.

Standards & Certifications

Flammability Standards: UL94V-0 rated housing & base
UL Recognition or CSA Certification: The ND Series rotaries have not been tested for UL recognition or CSA certification. These switches are designed for use in a low-voltage, low-current, logic-level circuit. When used as intended in a logic-level circuit, the results do not produce hazardous energy.

TYPICAL SWITCH ORDERING EXAMPLE

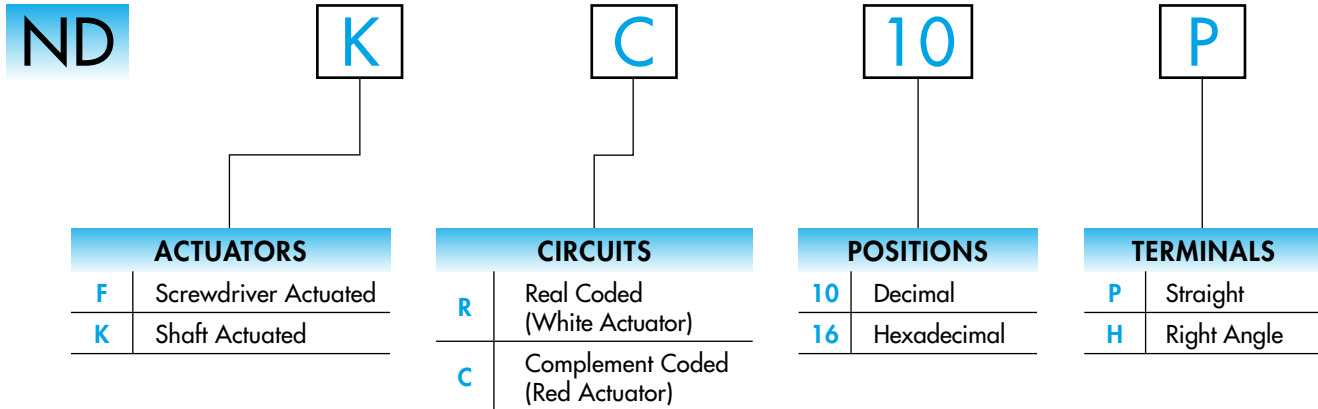

DESCRIPTION FOR TYPICAL ORDERING EXAMPLE

NDK10P



ACTUATORS

F Screwdriver Actuated

Actuator colors:
White for real coded
Red for complement coded

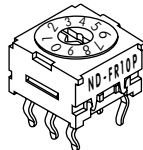

K Shaft Actuated

Actuator colors:
White for real coded
Red for complement coded

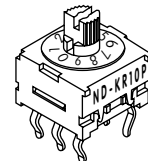

Actuators are fully rotational in either direction.

TRUTH TABLES (CIRCUITS & POSITIONS)

Actuator Position ● = ON		10 Decimal									16 Hexadecimal																		
		0	1	2	3	4	5	6	7	8	9	0	1	2	3	4	5	6	7	8	9	A	B	C	D	E	F		
R Real Coded Model Numbers: NDFR, NDKR	1		●		●		●		●		●		●		●		●		●		●		●		●		●		
	2			●	●			●	●			●	●			●	●			●	●			●	●			●	●
	4				●	●	●	●				●	●	●	●					●	●	●	●			●	●	●	●
	8					●	●	●	●	●					●	●	●	●	●			●	●	●	●	●	●	●	●
C Complement Coded Model Numbers: NDFC, NDKC	1	●		●		●		●		●		●		●		●		●		●		●		●		●		●	
	2	●	●			●	●			●	●			●	●			●	●			●	●			●	●		
	4	●	●	●	●					●	●	●	●							●	●	●	●						
	8	●	●	●	●	●	●	●	●						●	●	●	●	●										

TYPICAL SWITCH DIMENSIONS

Screwdriver Actuated • Straight PC

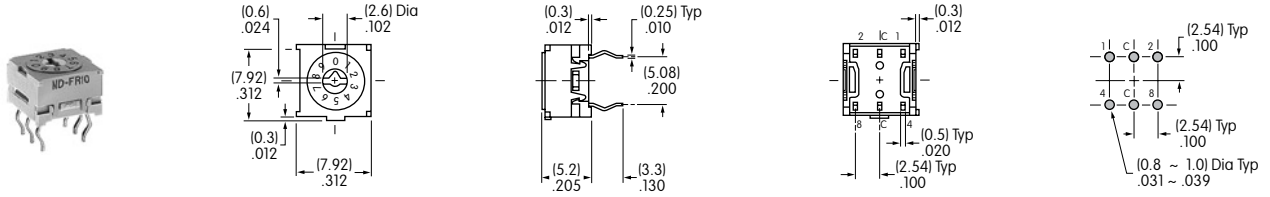

NDFR10P

Terminal numbers are not on switch

Shaft Actuated • Straight PC

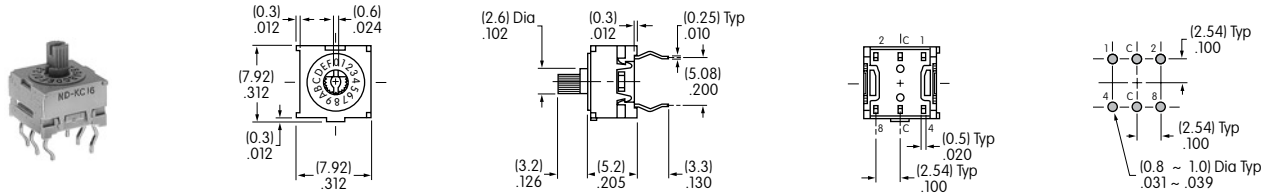

NDKC16P

Terminal numbers are not on switch

Screwdriver Actuated • Right Angle PC

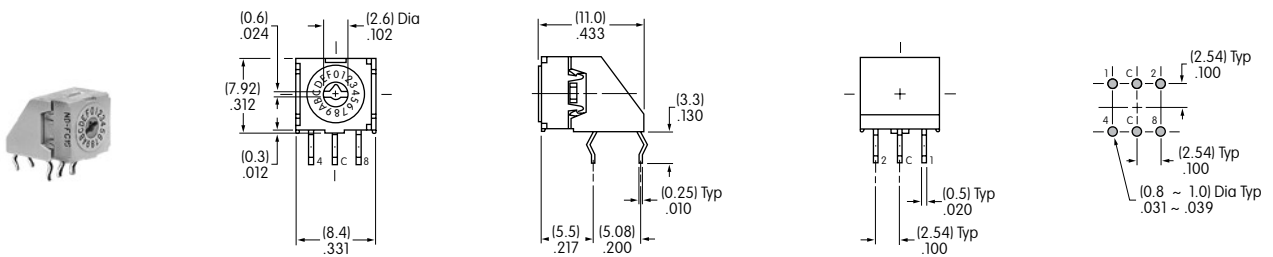

NDFC16H

Terminal numbers are on terminal cover

Shaft Actuated • Right Angle PC

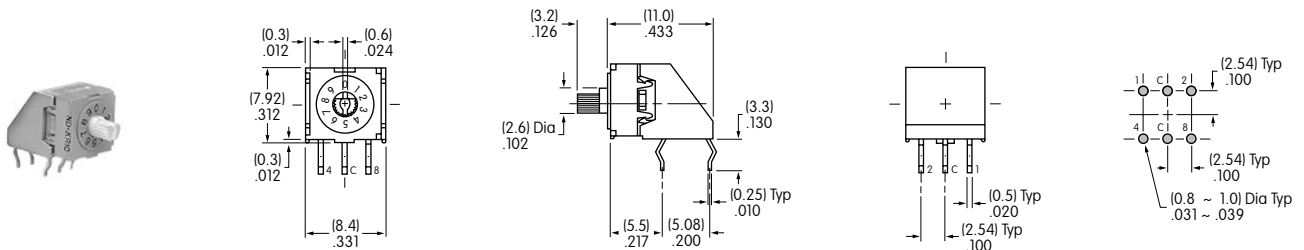

NDKR10H

Terminal numbers are on terminal cover